

DuraFLEX 2 - Step

The most durable seamless soft seating. Perfect for high traffic spaces like schools, libraries, healthcare, museums, retail, and more. Non-porous and waterproof flexible plastic shell with a flexible foam core. A solid base with fixed legs and the option for caster wheels for mobility. No hidden pockets or stitched seams where bacteria can hide and multiply. Surface can be readily washed and disinfected. Indoor use. Compliant with CAL133 Fire Testing and labeled accordingly. "MAS Certified Green" for healthier indoor air quality. Global Educator Institute (GEI) Endorsed.

With 1" Height Fixed Legs:

Item # 15022B1_ _ : 2-Step DuraFLEX, 32" Height, 163 lbs

Item # 15023B1_ _ : 3-Step DuraFLEX, 32" Height, 149 lbs

With 1.75" Caster Wheels w/Brakes:

Item # 15022BC_ _ : 2-Step DuraFLEX, 32.75" Height, 166 lbs

Item # 15023BC_ _ : 3-Step DuraFLEX, 32.75" Height, 152 lbs

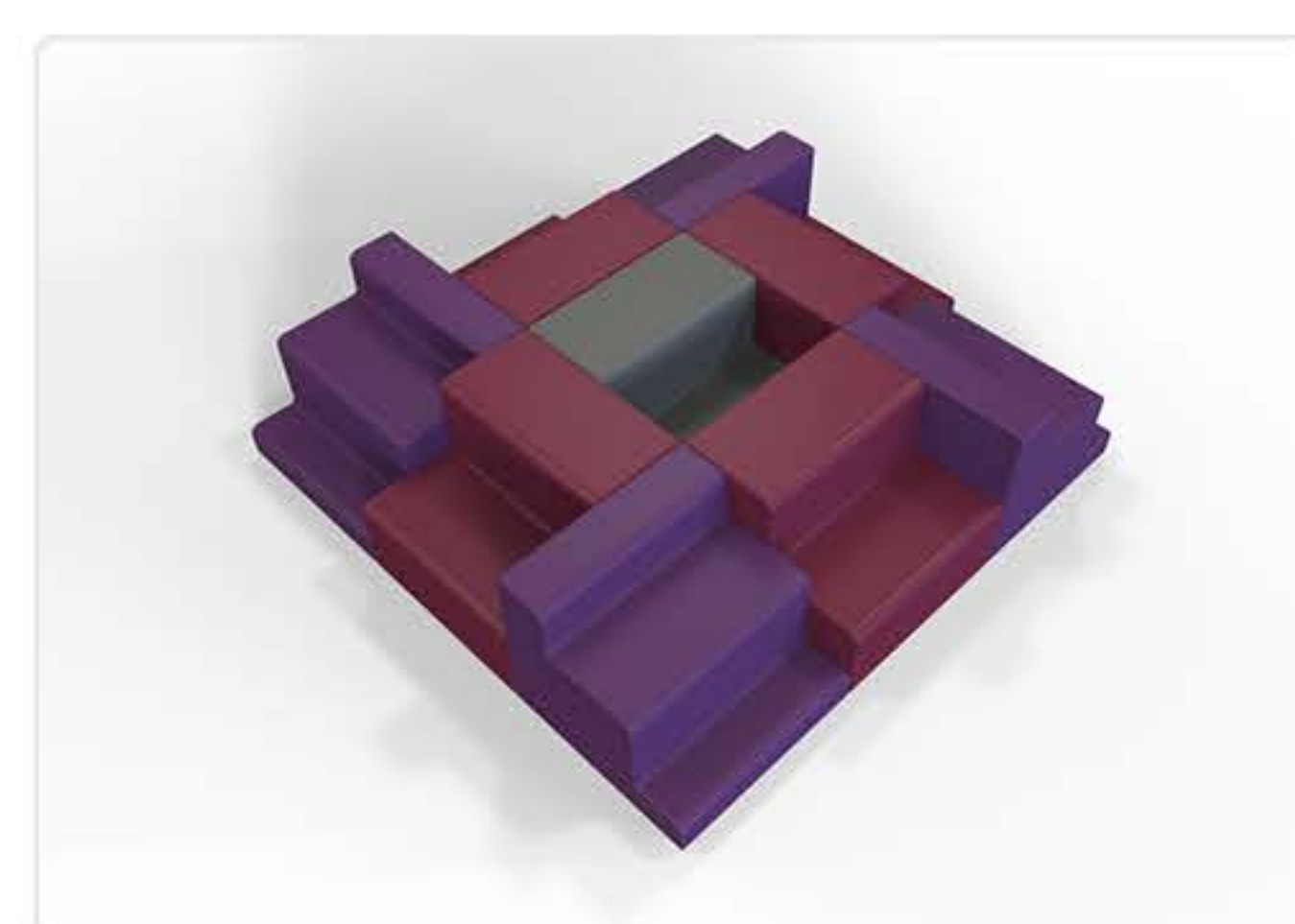
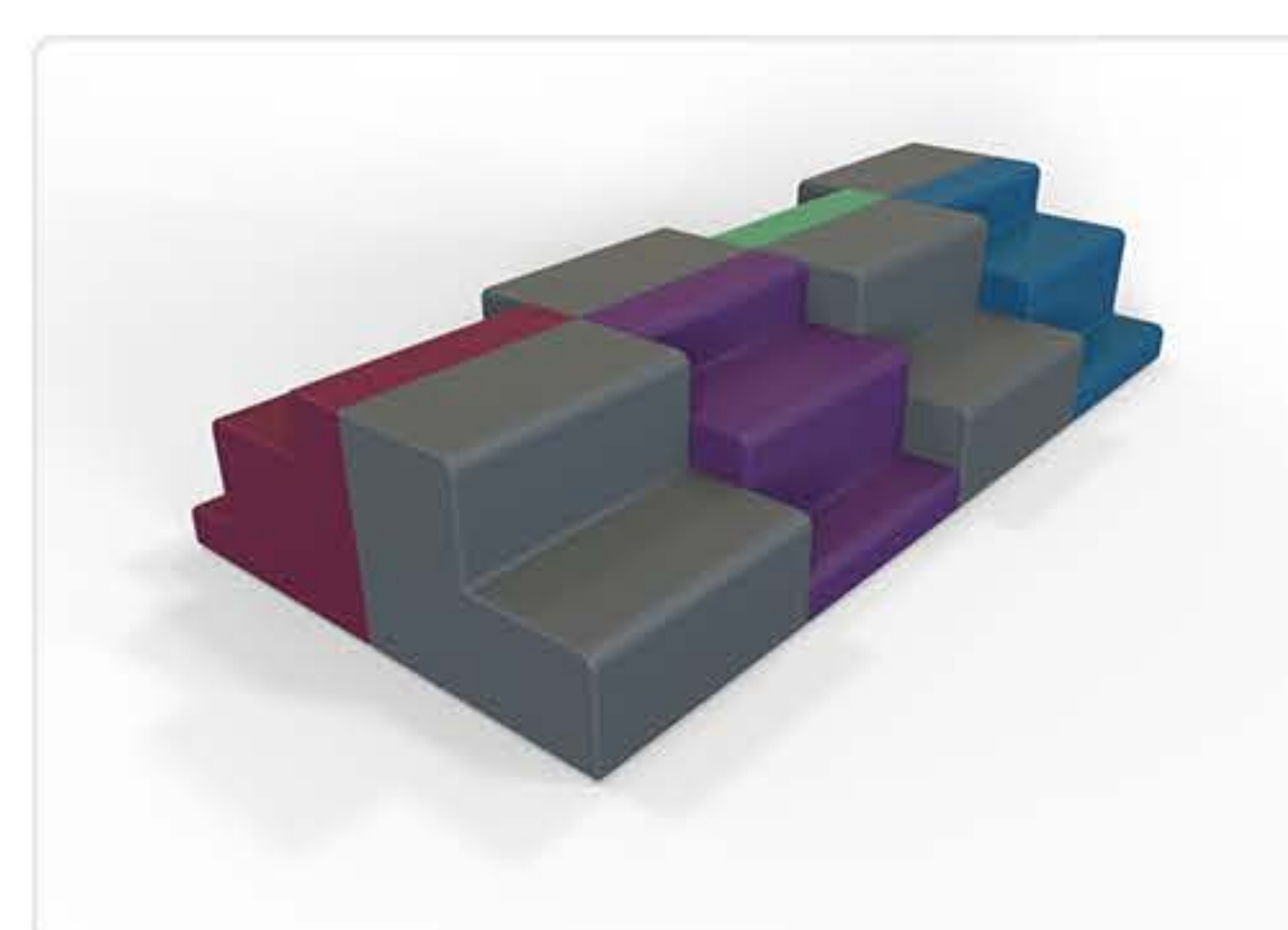
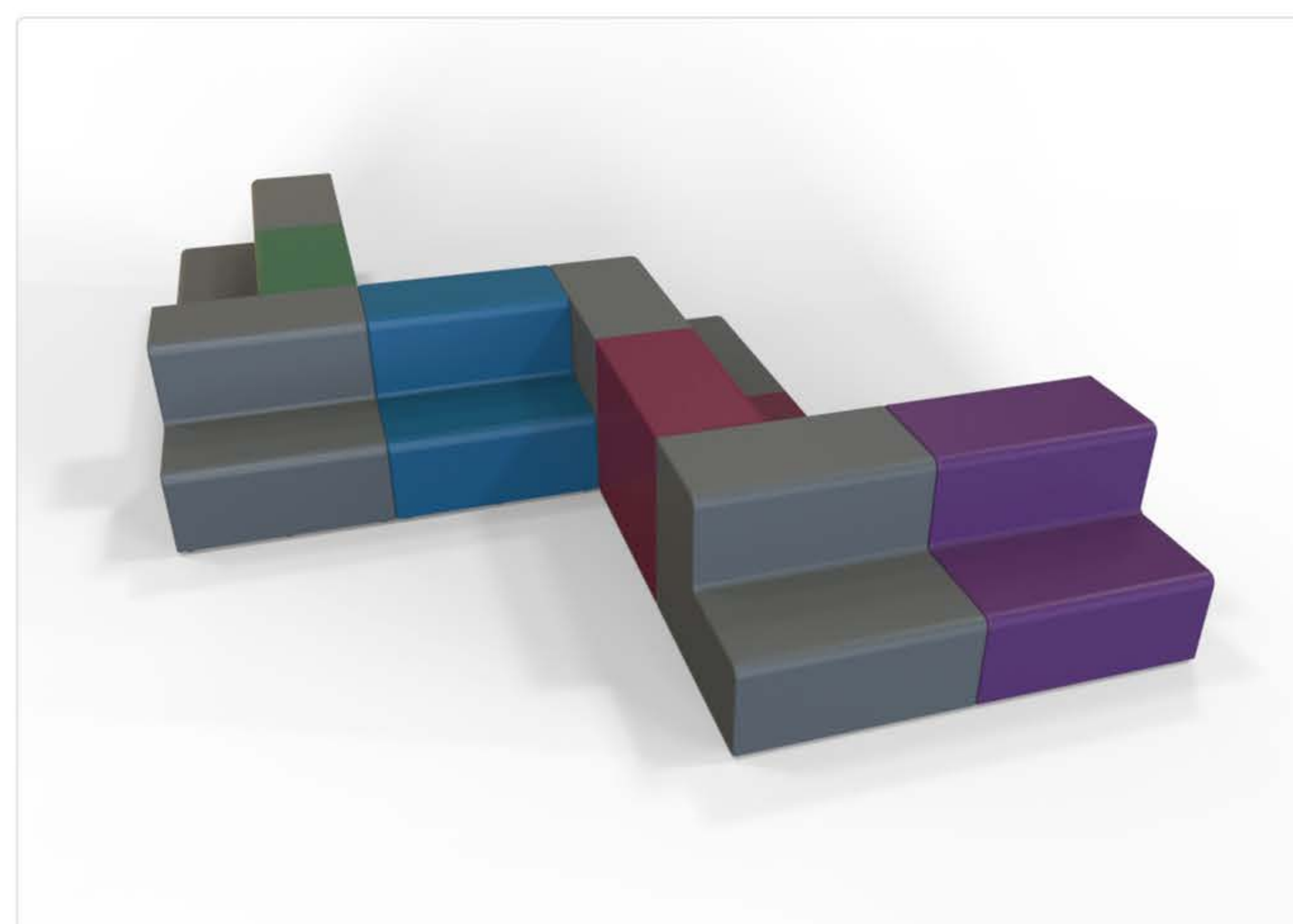
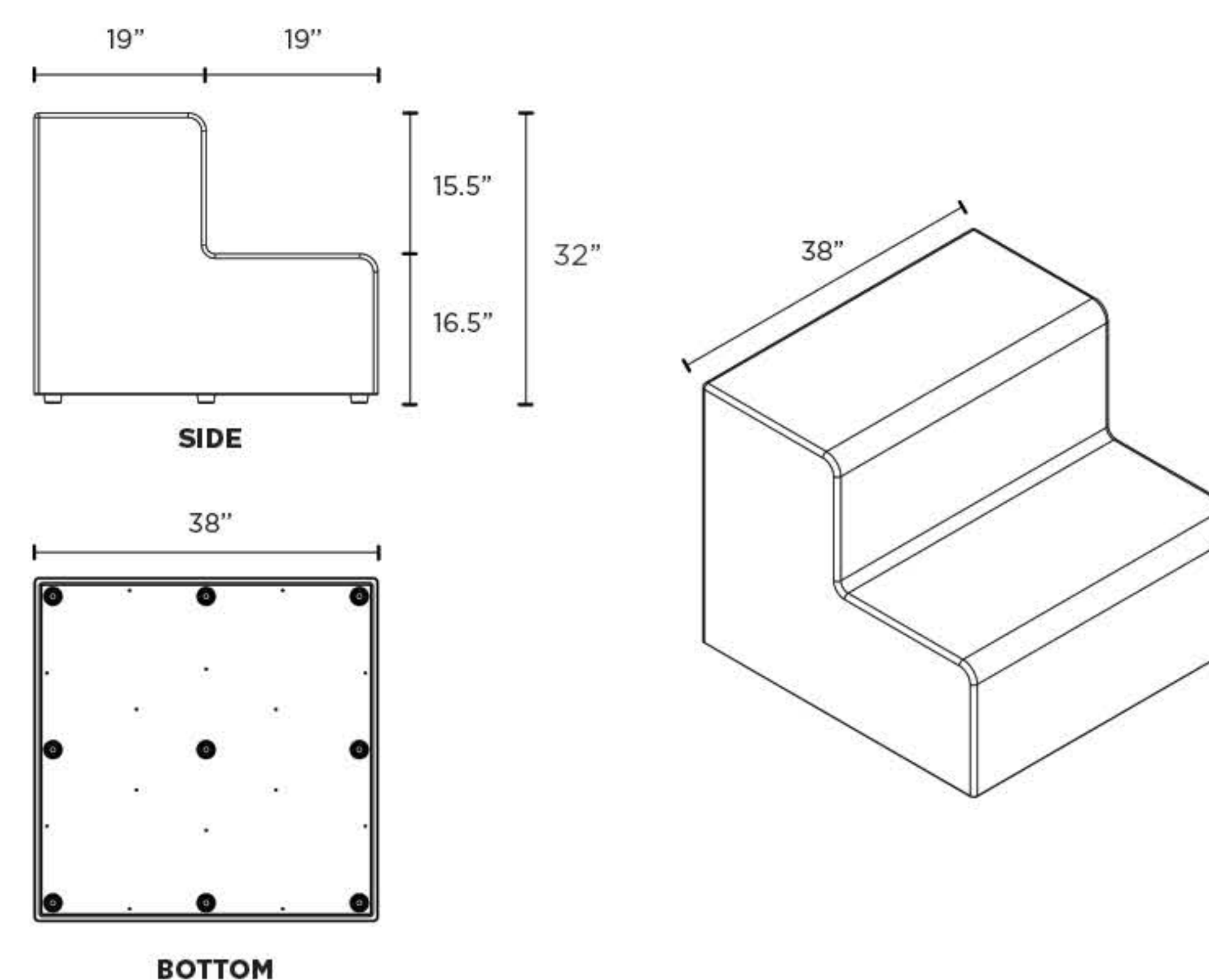

2 & 3 Step DuraFlex Standard Colors

