

# 2 - Step

DuraFLEX - Seamless Soft Seating



## With 2" Height Fixed Legs:

Item # 15022B2\_ \_ : 2-Step DuraFLEX, 33" Height, 163 lbs

Item # 15023B2\_ \_ : 3-Step DuraFLEX, 33" Height, 149 lbs

## With 2" Caster Wheels w/Brakes:

Item # 15022BC\_ \_ : 2-Step DuraFLEX, 33" Height, 166 lbs

Item # 15023BC\_ \_ : 3-Step DuraFLEX, 33" Height, 152 lbs

The most durable seamless soft seating. Perfect for high traffic spaces like schools, libraries, healthcare, museums, retail, and more. Non-porous and waterproof flexible plastic shell with a flexible foam core. A solid base with fixed legs and the option for caster wheels for mobility. No hidden pockets or stitched seams where bacteria can hide and multiply. Surface can be readily washed and disinfected. Indoor use. Compliant with CAL133 Fire Testing and labeled accordingly. "MAS Certified Green" for healthier indoor air quality. Global Educator Institute (GEI) Endorsed.

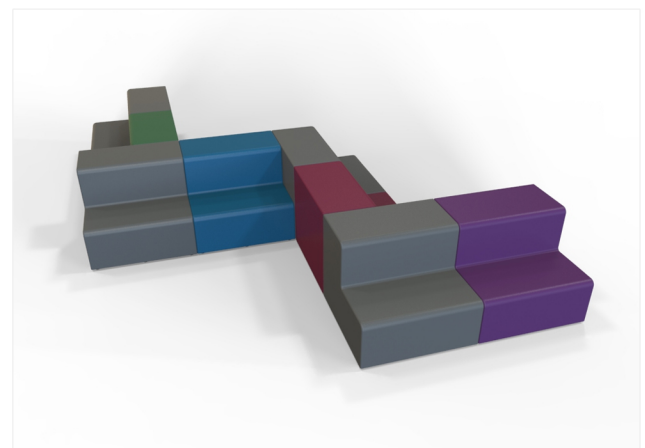
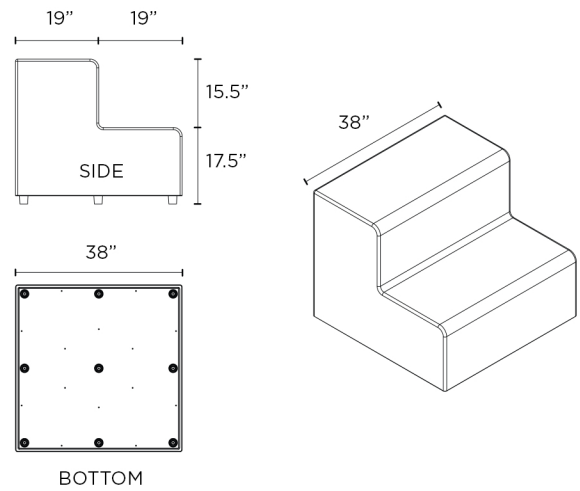

## 2 & 3 Step DuraFLEX Standard Colors



Maroon

Color Code: **MA**



Violet

Color Code: **VI**



Dark Purple

Color Code: **DP**



Dark Blue

Color Code: **DB**



Dark Green

Color Code: **DG**



Medium Blue

Color Code: **MB**



Anthracite Gray

Color Code: **AG**

