



MIBSTER

SPLASH & SESSION Series

Mibster has great ergonomics and a seat height that is comfortable for a wide range of people. Made with rotationally molded hard polyethylene material for supreme impact strength. Waterproof and weather resistant. Bring on the sun, sand, snow, salt, and rain...this chair can take it. Approximately 33 lbs.

- Easy to clean and sanitize.
- Ultra-low VOC emissions to promote healthy indoor air quality.
- Fire test compliant with CAL117-2013 and has zero added flame retardant chemicals.
- Supports up to 750 lbs.
- Rounded edges and corners for safety.
- Seat drains liquids and dries fast.
- 100% recyclable.



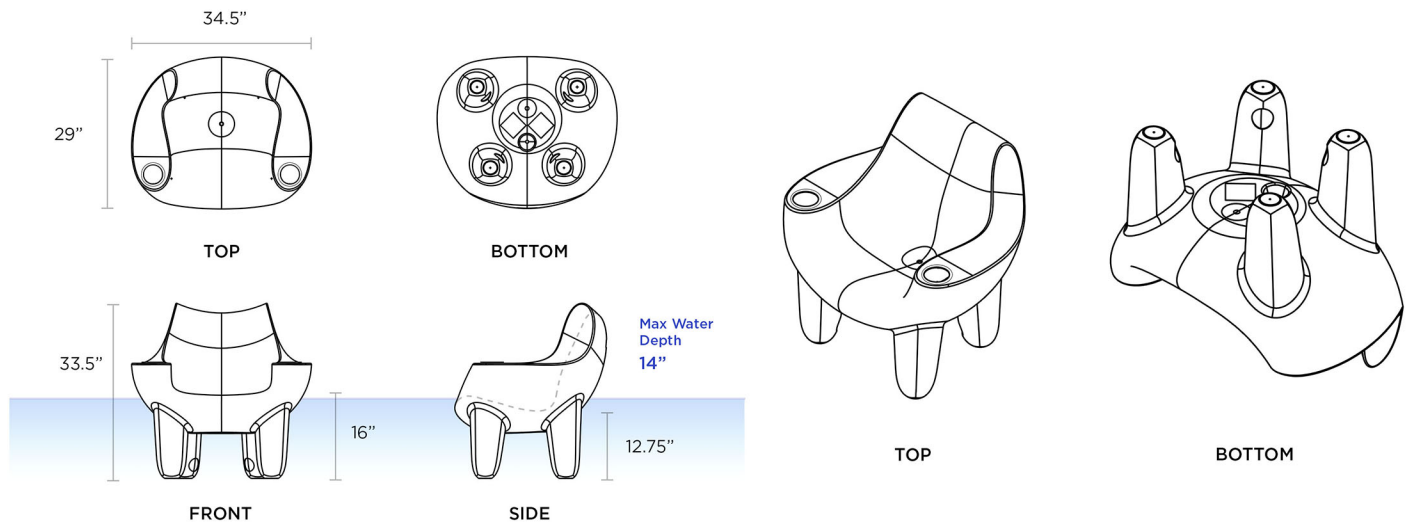

SPLASH PRODUCT INFO

This version has a 16" seat height and is designed to be placed in the shallow water of a swimming pool. The maximum water depth should not exceed 14". This version has a hole towards the base of each leg that allow water to enter and exit the core of the product. Set it in the pool and it rests in place. Pull it from the pool and it quickly releases the water from the core of the product so it can be used on the pool deck. This version has a carrying hole added to the back of the chair. Choose between black or white cupholders. This version does not have rubber legs or any metal components.

SPL22103BX __ BL - Splash Mibster Chair, Color TBD, Black Cupholders

SPL22103BX __ WH - Splash Mibster Chair, Color TBD, White Cupholders

SPLASH STANDARD COLORS



2 digit color code corresponds to the blank spaces in the product SKUs above.

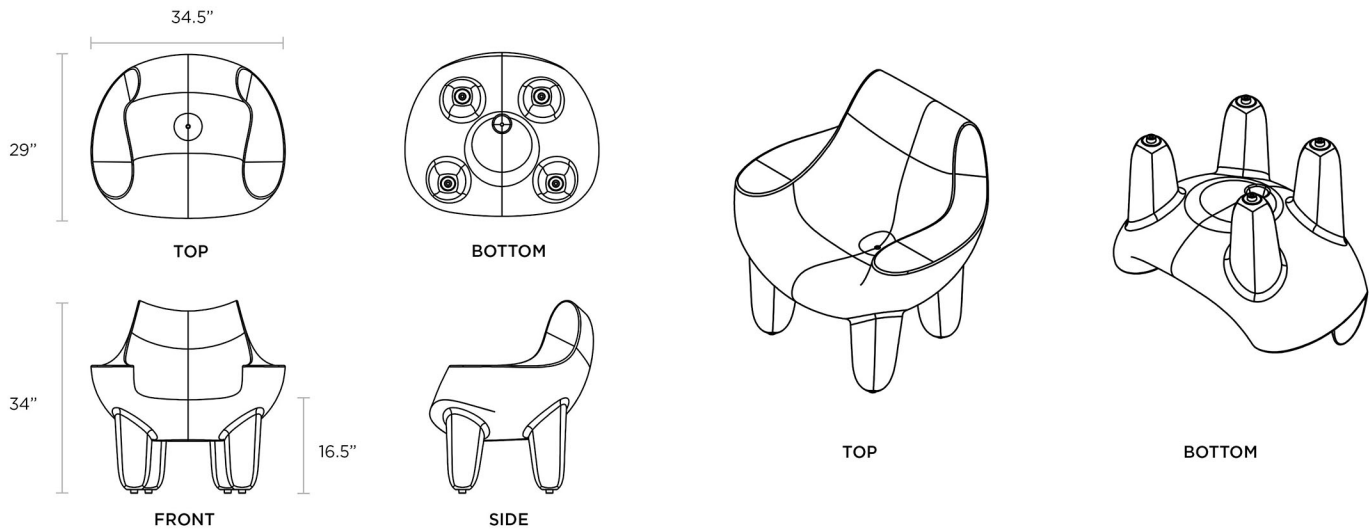

**SESSION
PRODUCT
INFO**

This version has a 16.5" seat height and includes Santoprene® rubber legs for floor grip and protection. This version does not have handles, cupholders, or openings on the bottom and is not modified for use in a swimming pool. This version does allow for the optional item #WEIGHTCAP.

#22103BX __ - Session Mibster Chair, Color TBD

Do you need seating that weighs more?

Are you furnishing a rooftop entertainment venue, condominium balcony, or public park? These are just some of the locations where your seating may need to have added weight for safety or theft prevention. Consider adding optional item #WEIGHTCAP to the Session Series version of Mibster Chair. When #WEIGHTCAP is added to the product, a 1.75" diameter screw plug is added to the bottom. This allows for pea-size gravel to be funneled into the core of the product for additional weight. This option is factory installed and must be added at the time of manufacturing. Installation supplies and gravel are not provided by Tenjam.

#WEIGHTCAP: Allows for adding up to 100 lbs of gravel. Approximately 133 lbs when filled.



2 digit color code corresponds to the blank spaces in the product SKUs above.

SESSION STANDARD COLORS



Lime Green
LM



Yellow
YE



Orange
OR



Red
RD



Violet
VI



Sea Foam Green
SF



Surf Blue
SB



Light Blue
LB



Medium Blue
MB



Dark Blue
DB



Desert Tan
DT



Medium Gray
MG



Anthracite Gray
AG



White
WH



Cobblestone
CS



Gray Granite
GG



River Rock
RR